

Product Overview

Discover our range of branded products

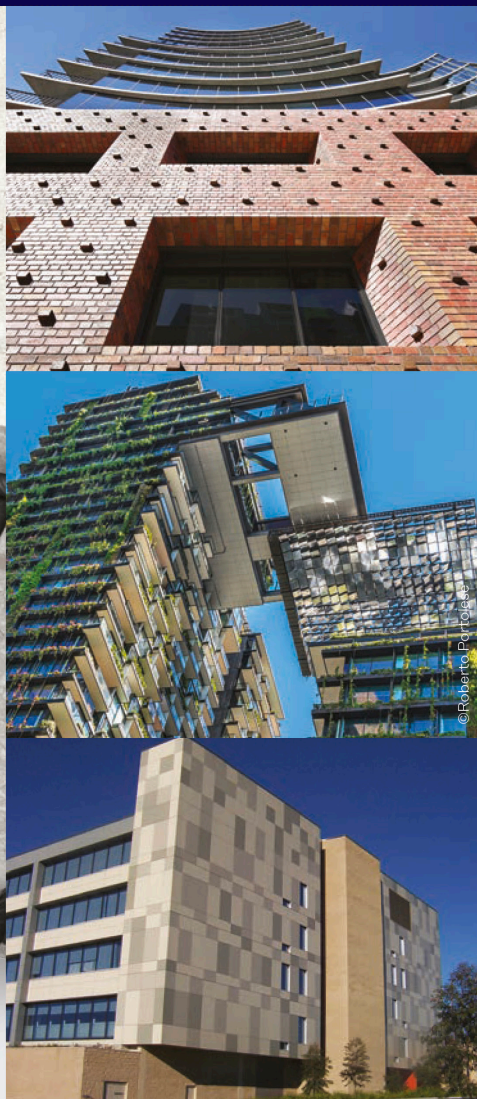

Australia Edition

Imagine. Model. Make.

Leviat®

A CRH COMPANY

We imagine, model and make engineered products and innovative construction solutions that help turn architectural visions into reality and enable our construction partners to build better, safer, stronger and faster.

Leviat is a world leader in connecting, fixing, lifting and anchoring technology.

From the build of new schools, hospitals, homes and infrastructure, to the repair and maintenance of heritage structures, our engineering skills are making a difference around the world.

We provide technical design assistance at every stage of a project, from initial planning to installation and beyond.

Our technical support services range from simple product selection through to the development of a fully customised project-specific design solution.

Every promise we make locally, has the commitment and dedication of our global team behind it. We employ almost 3,000 people at 60 locations across North America, Europe and Asia-Pacific, providing an agile and responsive service worldwide.

Leviat, a CRH company, is part of the world's leading building materials business.



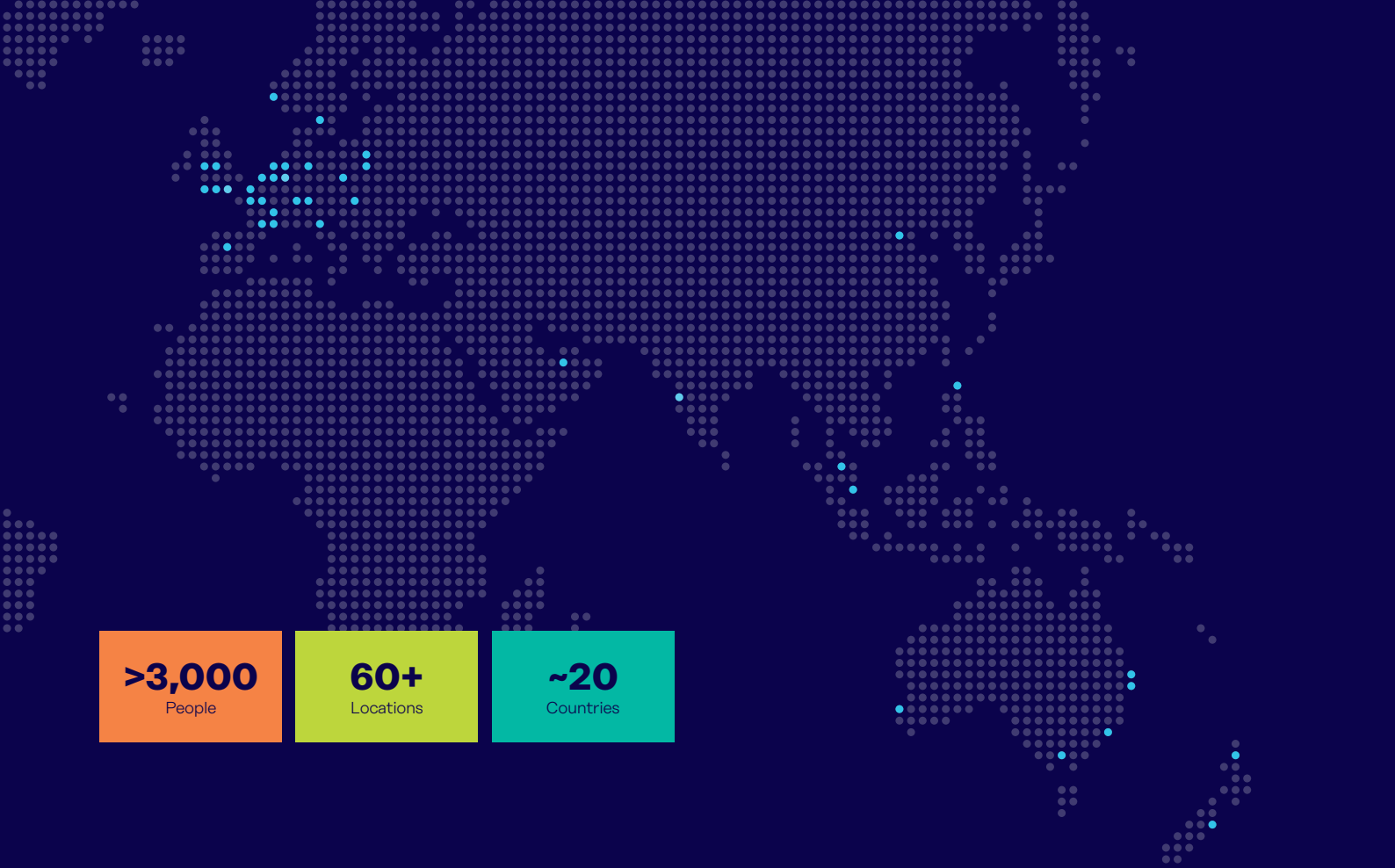

>3,000
People

60+
Locations

~20
Countries

Our areas of expertise:

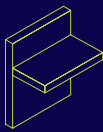

Structural Connections

Systems to form robust, efficient connections, and continuity of concrete reinforcement as necessary, between walls, slabs, columns, beams and balconies, providing structural integrity as well as enhanced thermal and acoustic performance.

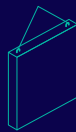

Lifting & Bracing

Systems for the safe and efficient transportation, lifting and temporary bracing of cast concrete elements and tilt-up panels before permanent structural connections are made.

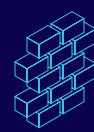

Façade Support & Restraint

Systems for the safe and thermally-efficient fixing of the external building envelope, including brick and natural stone, insulated sandwich panels, curtain walling and suspended concrete façades, and also the repair and strengthening of existing masonry installations.



Anchoring & Fixing

Systems for fixing secondary fixtures to concrete, including anchor channels, bolts and inserts; also tension rod systems for roofs and canopies.

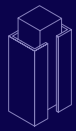

Formwork & Site Accessories

Non-structural accessories that complement our engineered solutions and help keep your construction environment operating safely and efficiently, including moulds for casting standard and special concrete elements and construction essentials such as reinforcing bar spacers.

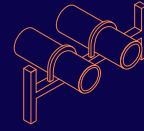

Industrial Technology

Mounting channels, pipe clamps and other versatile framing systems that provide safe fixing in a wide range of industrial applications.

Leviat product ranges:

Ancon | Aschwanden | Connolly | Halfen | Helifix | Isedio | Meadow Burke | Modersohn | Moment | Plaka | Scaldex | Thermomass

Leviat in Australia



Leviat in New Zealand

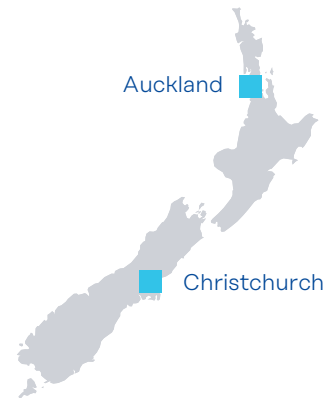

With five locations across Australia, and two in New Zealand, Leviat can assist with the specification, design, detailing and scheduling of a complete fixing solution for your project from our extensive range of trusted brands.

Our products are precision-manufactured to perform in the most demanding concrete and masonry applications, and are trusted for their integrity, reliability and compliance.

Our experienced technical specialists work closely with

developers, architects and structural engineers to ensure that our products meet the demands of today's most challenging construction programmes, while complying with new and emerging Australian Standards.

The advanced manufacturing facilities that we operate from meet the requirements of AS/NZS ISO 9001:2016. Our agile manufacturing processes enable us to respond quickly to fulfil urgent high-volume orders and meet challenging deadlines.

Our business is structured around meeting customer requirements efficiently and cost effectively. Our customer service professionals and extensive distribution network enable us to deliver the products that customers need, just when they're needed.

Contact us for help with your project requirements, from correct product selection to a fully customised design solution.

Tel: 1300 304 320
Email: info.au@leviat.com
Leviat.com



Products for Structural Concrete

Engineered concrete connections from the Ancon range include high performance shear connectors, threaded and bolted reinforcing bar couplers and reinforcement continuity systems.

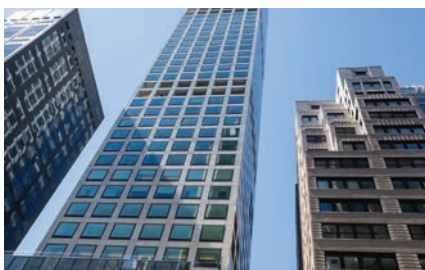

Products for Anchorage to Concrete

Leviat offers a wide range of intelligent fastening solutions as alternatives to drilling or welding. The Halfen range provides the ideal channel for every application, whether for elevator shafts, tunnels, stadiums or precast concrete construction.



High Integrity Fixings

Leviat has a wealth of experience of working with various types and grades of stainless steel, and can produce special fabrications to suit individual customer requirements in a variety of industries.



Products for Precast Concrete

Our product portfolio comprises edge lifting systems, lifting loops and cast-in threaded inserts to ensure safe, fast and efficient handling of a wide range of precast concrete elements.



Products for Slab-On-Ground Applications

Connolly and Isedio joint solutions enable flooring contractors to cast flat, high performing concrete floors. The range covers all applications, from the light-duty footpaths to heavy-duty industrial warehouse slabs.



Products for Brick, Block & Stone

Ancon MDC masonry support systems combined with Ancon wall ties, windposts and lintels form a complete stainless steel fixing solution for aesthetic masonry cladding on new buildings.

Products for Masonry Repair

Helifix repair and reinforcement products, with their concealed non-disruptive installation techniques, help to preserve our built environment and strengthen existing masonry structures.

Contents

Products for Structural Concrete	6
Shear Load Connectors	
Punching Shear Reinforcement	
Reinforcing Bar Couplers	
Reinforcement Continuity Systems	

Products for Precast Concrete	8
Lifting Systems	
Threaded Inserts	
Lifting Loops	
Magnetic Formwork Clamps	
Precast Connectors	
Column Shoes	
Socket Bars	
Pre-stressing Accessories	

Products for Anchorage to Concrete	10
Anchor Channels	
Elevator Accessories	

Products for Slab-On-Ground Applications	12
Expansion Joint Systems	
Universal Dowel Sleeves	
Biscuit Plate Dowels	
Key Joint	
Dowel Cradles	
Straight Up Contraction Joints	
Edge Protection Joint Systems	

High Integrity Fixings	14
Tension and Compression Systems	
Stainless Steel Reinforcement	
Stainless Steel Fabrications	
Weld-Free Steel Connectors	

Products for Brick, Block & Stone	16
Masonry Support Systems	
Lintels	
Channel & Bolt Fixings	
Wall Ties & Restraint Fixings	
Windposts & Parapet Posts	
Masonry Reinforcement	

Products for Masonry Repair	18
Crack Stitching Systems	
Remedial Wall Ties	
Mechanical Pinning Systems	
Piled Foundation Systems	

Products for Structural Concrete



Ancon DSD Shear Load Connector



Ancon Lockable Dowel

Accommodating Shear

Ancon Shear Load Connectors

Installed at expansion and contraction joints, Ancon Shear Load Connectors are more effective at both transferring load and accommodating movement than plain dowel bars. Each connector is a two-part assembly, comprising a sleeve and a dowel component. Products are available for joints in ground bearing and suspended slabs. Our free design software is available to download from the website.

Ancon Lockable Dowels

The range includes a unique lockable dowel designed for use at temporary movement joints in post-tensioned concrete frames.

Ancon Punching Shear Reinforcement

This Ancon Shearfix System consists of double-headed studs welded to flat rails. It is used within a slab to provide additional reinforcement around columns, protecting the slab from the effects of punching shear. Our free design software is available to download from the website.

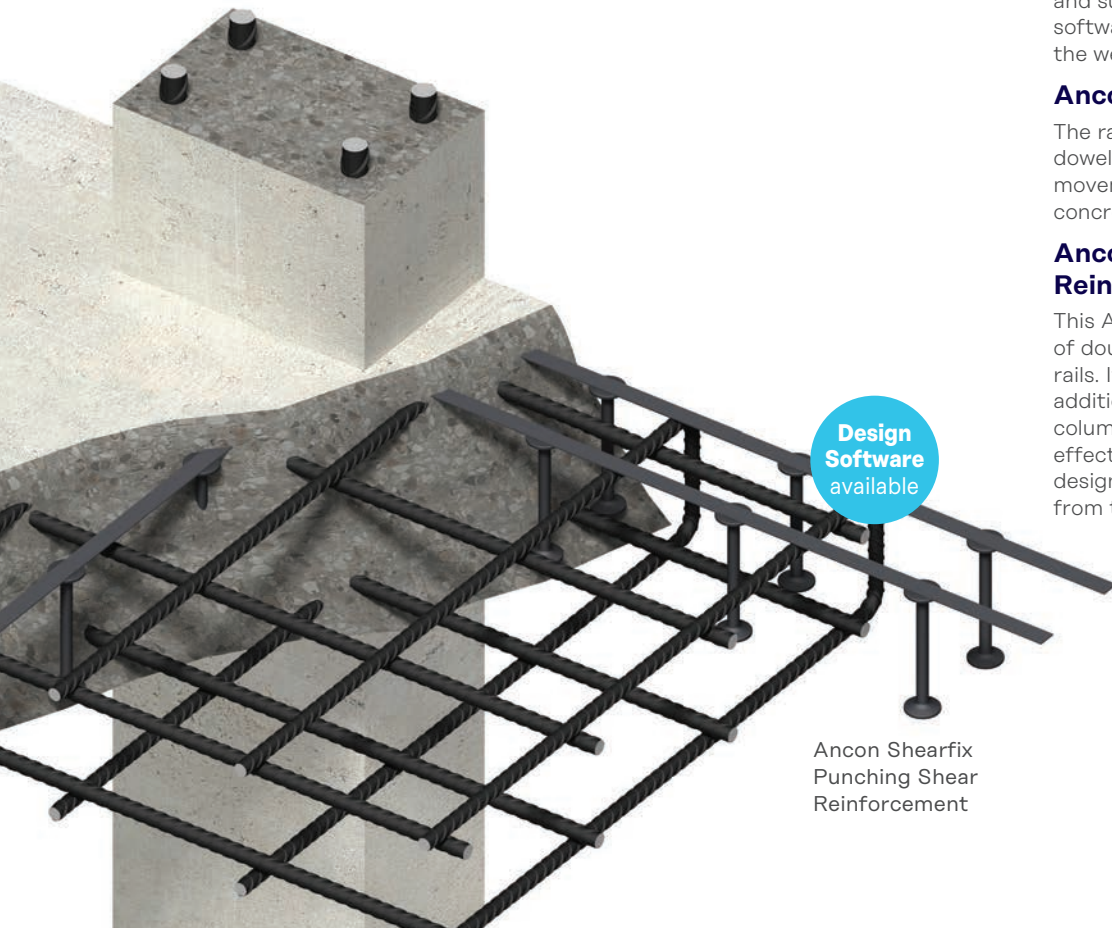

Ancon Shearfix
Punching Shear
Reinforcement

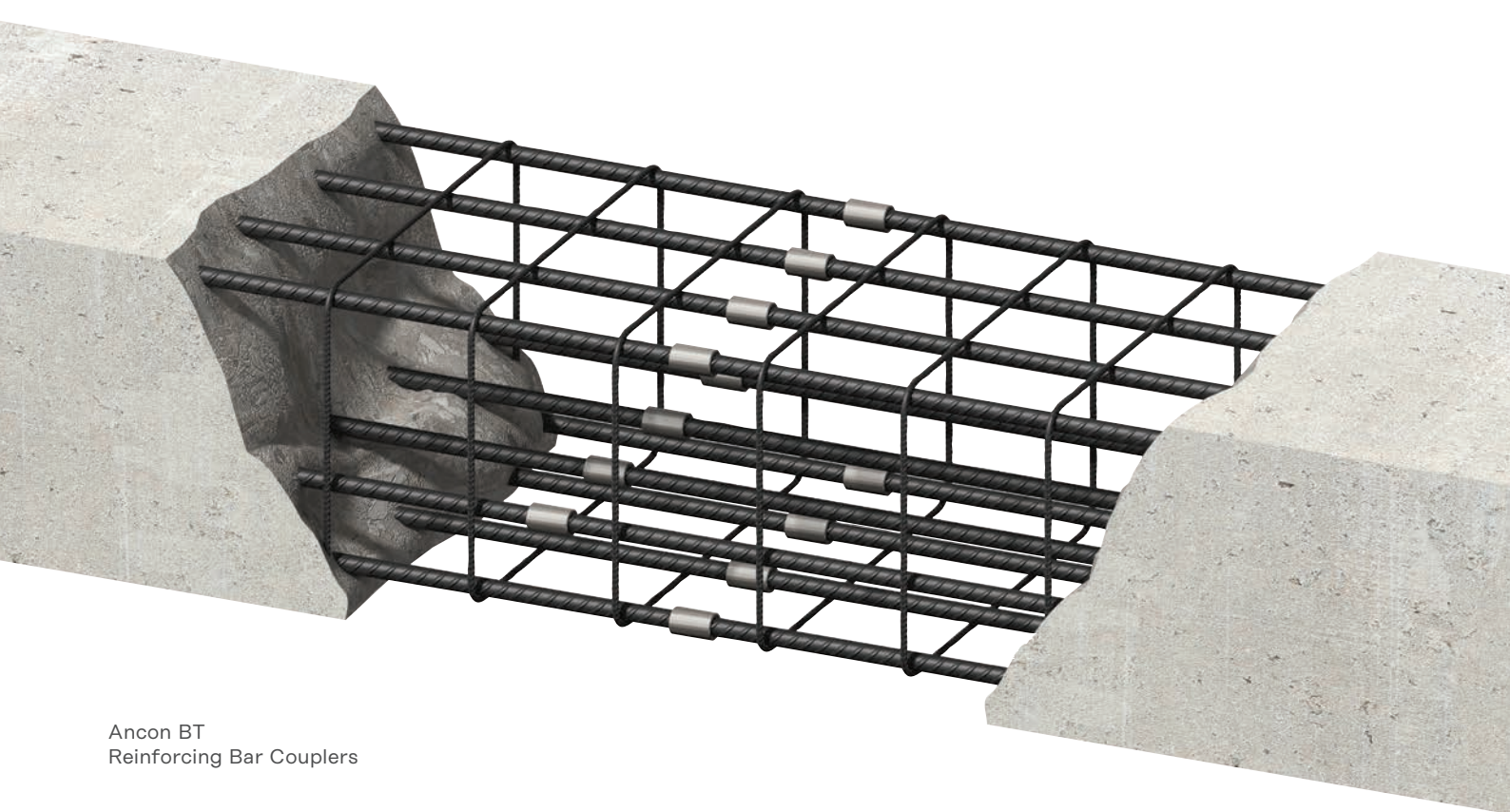

Ancon BT
Reinforcing Bar Couplers

Continuity of Reinforcement

Ancon Reinforcing Bar Couplers

Couplers can be used to replace long bars, simplify design details, reduce rebar congestion and accelerate the speed of construction. The Ancon range includes parallel threaded and mechanically bolted couplers.

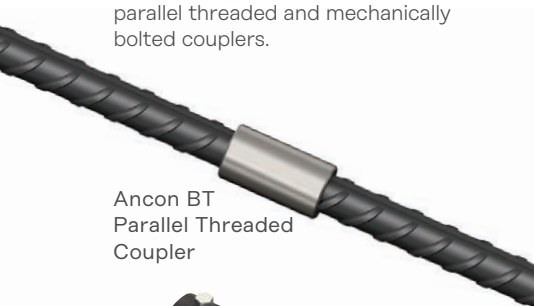

Ancon BT
Parallel Threaded
Coupler

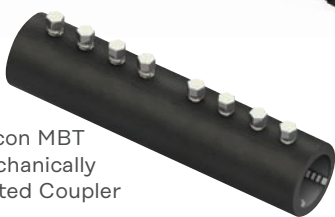

Ancon MBT
Mechanically
Bolted Coupler

Moment Grout Couplers

Moment Grout Couplers can be used either for precast or in-situ connections where additional tolerance is needed and the reinforcing bars cannot be threaded or prepared. They consist of a sturdy one piece steel sleeve, which is filled with a high strength, flow-able, shrinkage equalised grout to provide a bond between the starter bar and the grout coupler sleeve.

Moment Full
Grout Coupler



The Ancon BT system is one of the smallest and the most cost-effective coupler systems in our range, when used on large scale, high coupler volume projects. The ends of the bars are enlarged and a parallel thread is cut onto the ends to suit the threaded coupler. The coupler is assembled using a pipe or chain wrench. Calibrated wrenches are not necessary.

Ancon Reinforcement Continuity Systems

Ancon Keybox consists of pre-bent bars housed within a galvanised steel casing. Once installed, the protective cover is removed and the bars are straightened.

Ancon KSN Anchors with BT threaded reinforcing bars can simplify concrete design at construction joints, typically in slab-to-wall applications. The anchor is cast into the face of the concrete wall. When the formwork and thread protection is removed, the reinforcing bar is screwed into the anchor.

Ancon KSN Anchors are also available in a galvanised steel casing to provide a shear key (Ancon KSN Anchor Box) or a reusable plastic mould (Ancon KSN Anchor Block). Continuity of reinforcement can be also provided by the installation of an Ancon Coupler Box. These boxes combine standard Keybox casings with the Ancon BT mechanical splicing system.

Ancon Keybox



Ancon KSN Anchor Box



Ancon Coupler Box

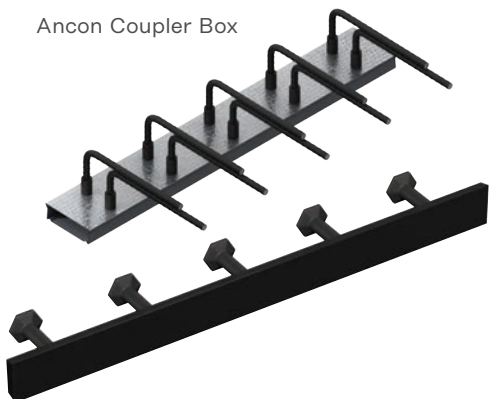

Ancon KSN Anchor Block



Ancon KSN Anchor

Products for Precast Concrete



Precast Concrete Accessories

Ancon Unilift Lifting System

Unilift Locking Klaws and spherical head anchors are the ideal lifting and handling system for a wide variety of precast concrete products, particularly in civil engineering applications.

Ancon EdjPro Edge Lifting System

The Ancon EdjPro system is ideal for lifting thin factory cast panels where a high finish is required, typically visible and exterior walls.

Use of the EdjPro system ensures panels remain in their perfect factory-cast condition, avoiding remedial work and lowering overall costs.

The range comprises four lifting anchors with working load limits of 4, 8.5, 10 and 15 tonnes in tension.

Ancon QwikFoot and QwikFix Threaded Inserts

A wide range of cast-in inserts are available, which provide a metric thread fixing point in precast concrete panels. They are available in thread sizes from M12 to M24 in either zinc plated, hot dip galvanised or stainless steel. Chairs are available to simplify installation by keeping the unit stable during casting.

Ancon LinkPro Loops

LinkPro fibre-cored/steel-cored lifting loops facilitate the safe and efficient handling of large precast reinforced concrete units, including bridge and shell beams.



Ancon Unilift Locking Klaw and Cone Anchors

Ancon EdjPro EPHIMini Edge Lifting System

Ancon QwikFoot and QwikFix Threaded Inserts

Ancon LinkPro Lifting Loops

Halfen HEK Precast Connectors

The Halfen HEK Precast coupler is an innovative and versatile solution for fast and easy connection of precast concrete elements. Cast-in threaded inserts, i.e. Ancon QwikFoot, transfer the tension and shear force into the precast element. The main advantage of the system is the fast and efficient positioning of precast elements. The connection can be subjected to load immediately after installation, which results in a substantial improvement in construction time.

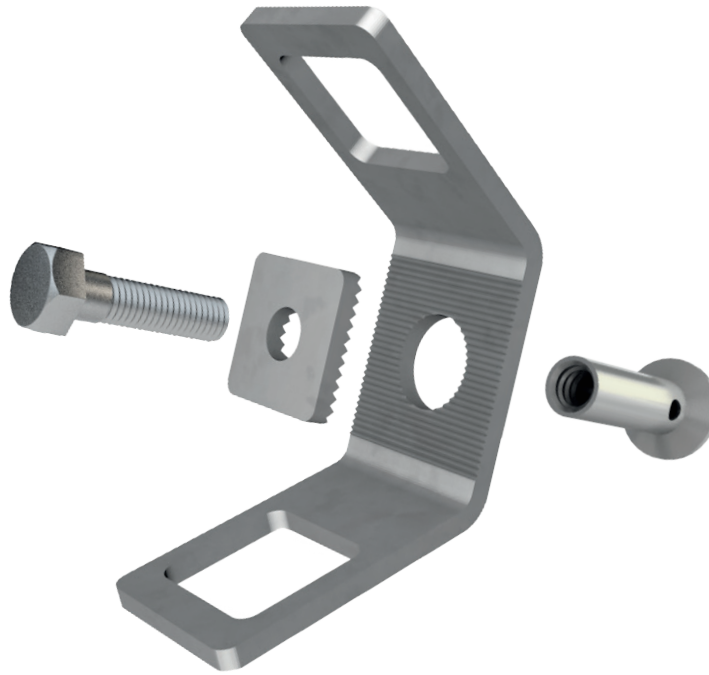

Ancon QwikMag Magnetic Clamps

These high strength magnetic clamps lock firmly in place on steel casting beds to hold formwork in position and help create consistent straight edges to precast concrete panels.



Ancon QwikMag Magnetic Clamps

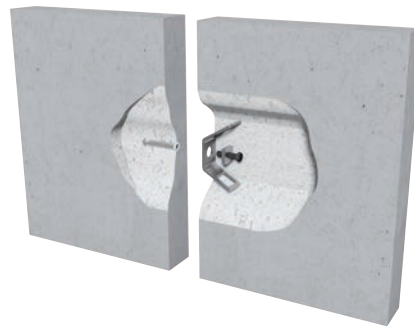

Halfen HEK Precast Connector

Reinforcement

Ancon MuscleStart Socket Bars

This is a starter bar system which provides a full bar strength joint for precast concrete panels and floors.



CCL Pre-stressing Accessories

Open grips, double-ended joints and spring loaded anchors

Reliable pre-stressing products. Batch marked for full traceability.



Halfen HCC Column Shoes

Halfen HCC Column Shoes, when used in conjunction with HAB Anchor Bolts, are a fast and efficient means of connecting precast concrete columns to foundations.



Products for Anchorage to Concrete

Fixing Systems

Halfen Anchor Channels

When fixing to concrete, Halfen Anchor Channels provide almost unlimited adjustment along the line of the channel and can eliminate expensive site drilling. Halfen Anchor Channels are available in hot dip galvanised steel or stainless steel, depending on the level of corrosion resistance required.



Halfen HTA Anchor Channels

Halfen HTA Anchor Channels with smooth lips, used in conjunction with Halfen HS T-Bolts, resist tension loads and shear loads in the direction perpendicular to the longitudinal axes of the channel. Halfen HTA Anchor Channels hold a European Technical Assessment and comply with AS 5216:2021.

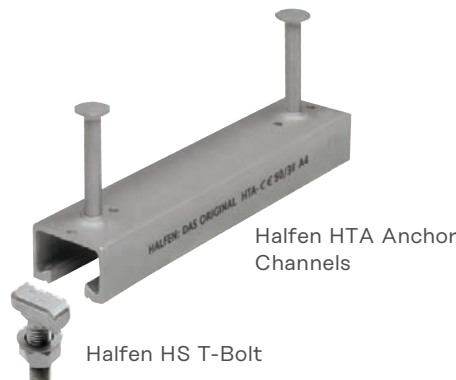

Halfen HZA Serrated Anchor Channels

Halfen HZA Serrated Anchor Channels with toothed lips, used in conjunction with Halfen HZS T-Bolts, provide resistance in all directions including the longitudinal axes of the anchor channel. Halfen HZA Toothed Anchor Channels comply with the latest revision of AS 5216:2021.



Elevator Guide Rail Connected By Anchor Channel

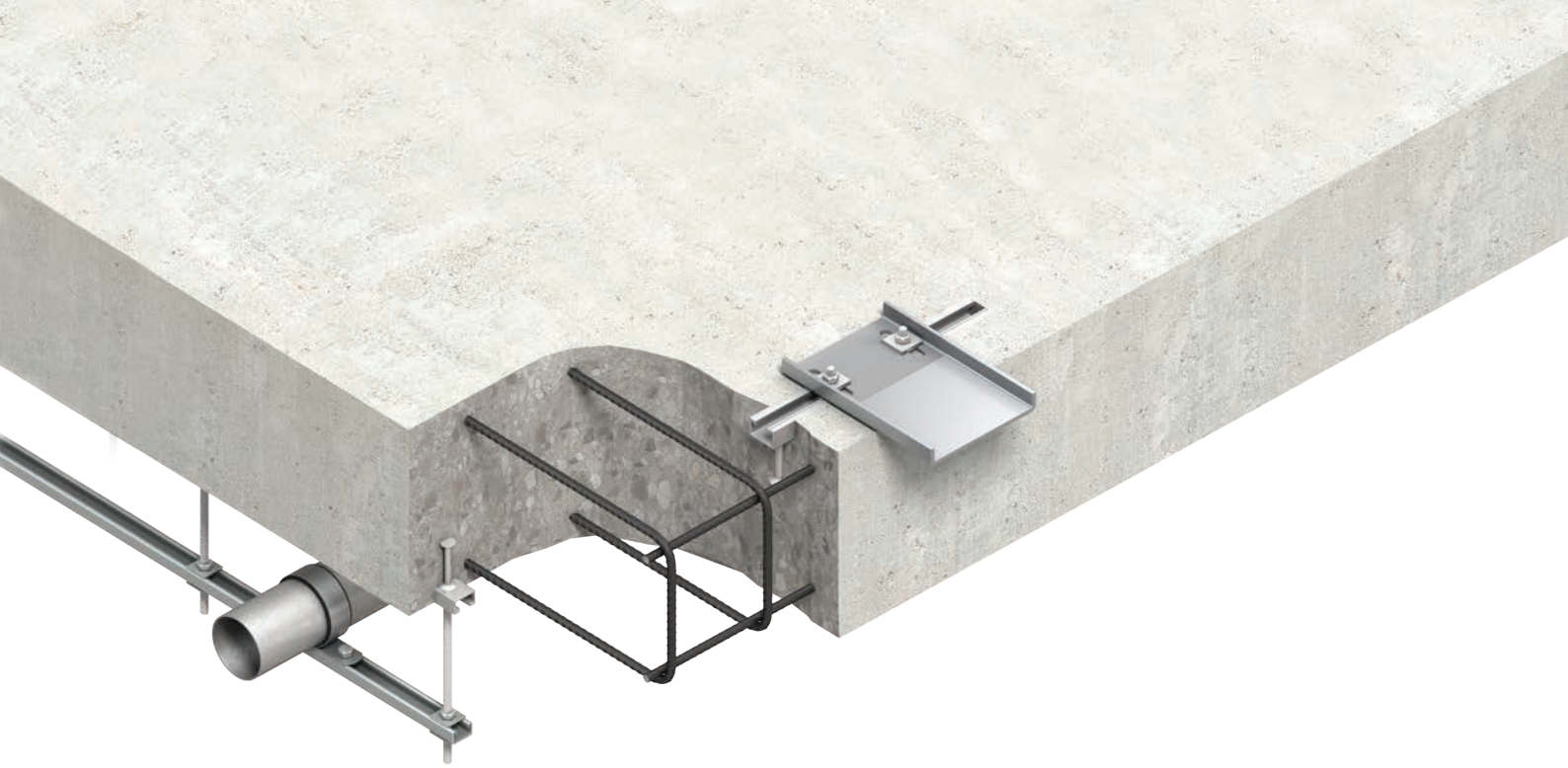

Elevator Accessories

Halfen HLX Lift-Box

The increasing importance of scaffold-free elevator installation requires attachment points cast into the ceiling of concrete shafts for temporary attachment of various loads.

The Halfen HLX Lift-Box makes this possible, providing a safe, temporary fixing point for hoisting apparatus, speed governor/limiter, motor and other equipment during initial installation and subsequent maintenance of an elevator.



Products for Slab-On-Ground Applications

Floor Joint Solutions



Connolly EXJ Expansion Joint System

The EXJ Expansion Joint System is a continuous pour solution for expansion joints in slab on-ground applications.



Connolly Universal Dowel Sleeves

Universal Dowel Sleeves are available for round and square dowels to allow for load transfer across joints in slab-on-ground applications. The patented twist-fix feature and integrated support leg assist with accurate dowel alignment.



Connolly Biscuit Plate Dowels

Biscuit Plate Dowels and Sleeves are designed to transfer loads across construction joints in slab-on-ground applications.



Connolly Dowel Cradles

Dowel Cradles are used for load transfer in saw cut contraction joints. They are a welded wire assembly that ensures the horizontal and vertical alignment of dowels at the correct spacing and height.

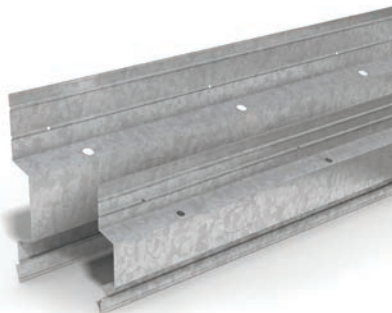

Connolly Key Joint

Connolly Key Joints are a roll-formed galvanised steel section used as a leave-in-place formwork system to control shrinkage induced cracking. The profile is fixed in place using our patented peg and wedge system.

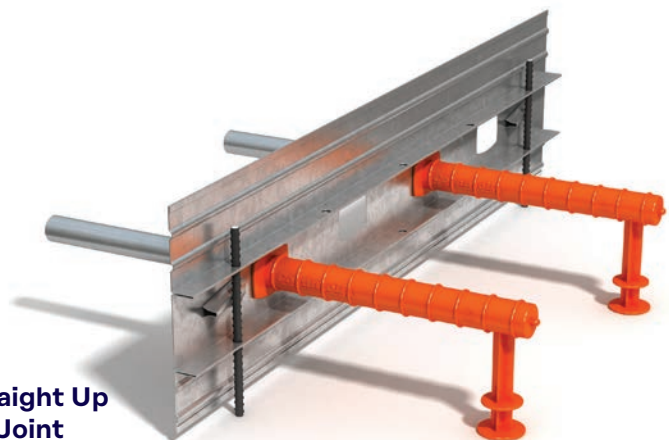

Connolly Straight Up Contraction Joint

The Connolly Straight Up Contraction Joint is a continuous pour solution for contraction joints in slab-on-ground applications.

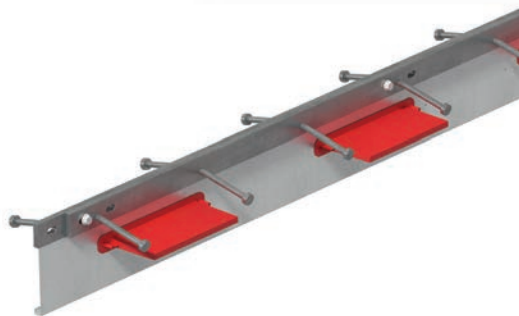
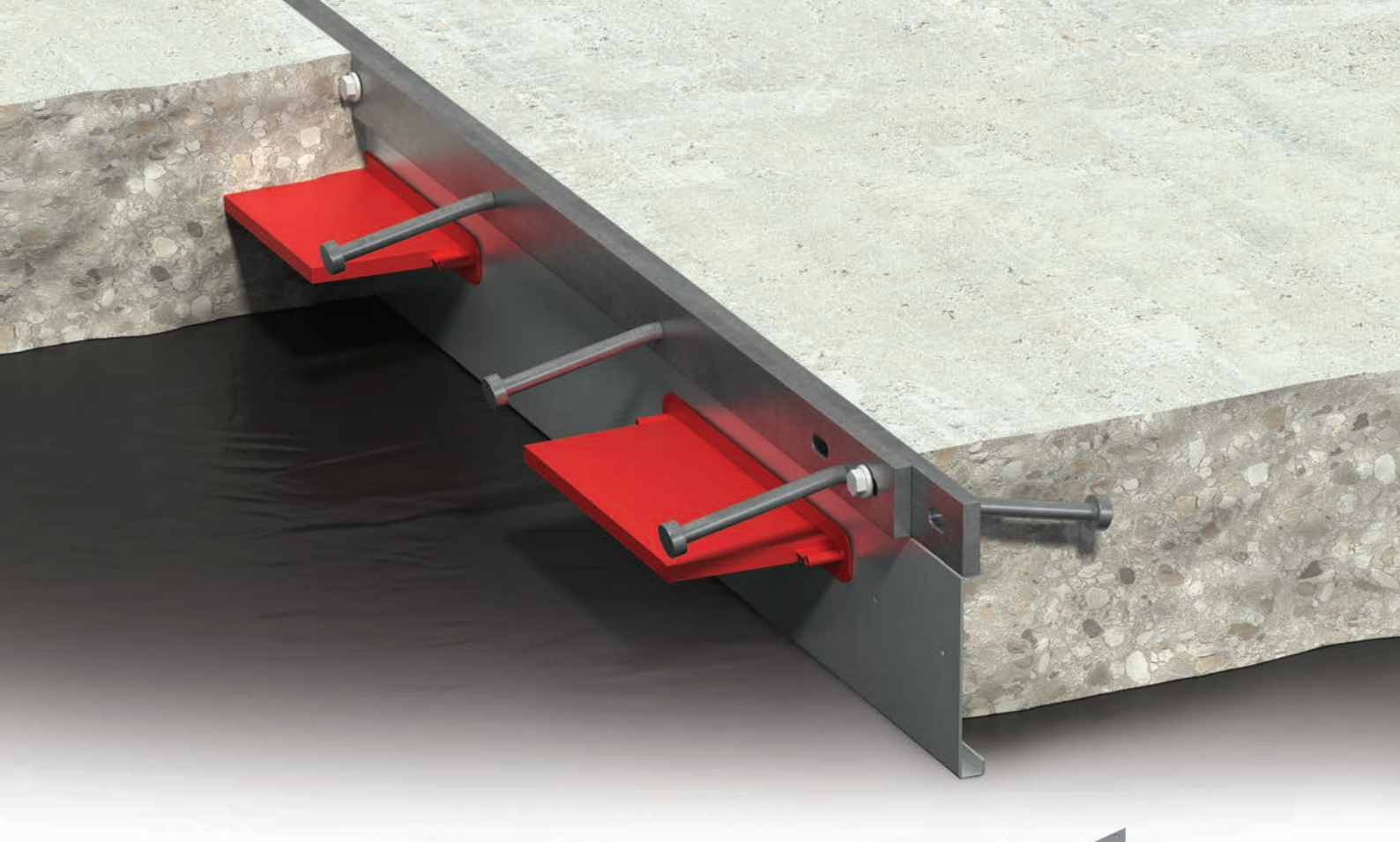

Isedio ArmourJoint

ArmourJoint is a leave-in-place formwork, load transfer and edge protection joint system suitable for heavy duty industrial concrete floors.

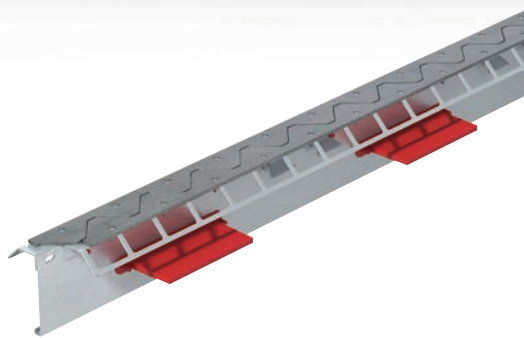

Isedio GuardJoint

GuardJoint adds to the ArmourJoint features, a disruptive face top plate and continuous anchor wings, providing silent, smooth wheel travel across joint openings up to 25mm. Suitable for heavy duty industrial concrete floors.

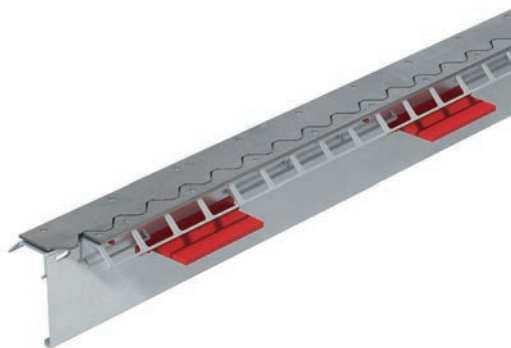

Isedio ShieldJoint

ShieldJoint builds on the value of GuardJoint, adding a sealant-free joint design to the list of features, making it the ultimate in slab edge protection. Suitable for heavy duty industrial concrete floors.



Isedio SteelDeckJoint

SteelDeckJoint is a revolutionary floor joint solution, which solves many of the deficiencies and time consuming elements of forming a construction joint on a steel deck floor using timber formwork.

High Integrity Fixings

Tension & Compression Systems

In addition to providing a high load capacity, these stylish Ancon systems meet the demanding aesthetic requirements of today's architectural applications. Both systems are available in carbon and stainless steel in a variety of sizes and finishes including hand polished.

Components combine to create fixing solutions for staircases, canopies, timbers and large areas of glazing.

Tension Systems comprise high strength bar, fork connectors, locking nuts, couplers and anchor discs.

Compression Systems comprise high strength tubes, fork connectors and locking nuts.



© Darcy Schack JAM Photographics Ltd



Electro-polished Tension System

Satin-polished Tension System

Hand-polished Tension System

Hand-polished Compression System

Stainless Steel Reinforcement

Reinforcing Bar

Leviat supplies stainless steel plain and ribbed bar direct from stock. Bars can be supplied cut to length, bent and threaded to suit any application.



Stainless Steel Fabrications

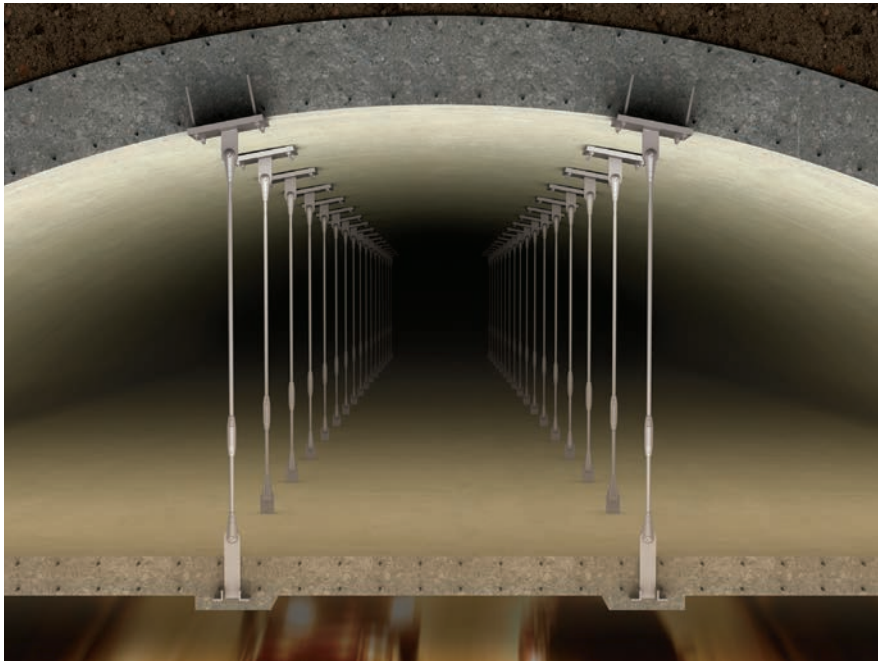

Tunnel Ceiling Suspension Systems

Leviat has a wealth of experience of working with various types and grades of stainless steel, and produces special fabrications to suit individual customer requirements. Both one-off and volume orders have been supplied to various industries such as Building, Infrastructure, Water Treatment, Nuclear and Mining.

Leviat has an impressive project portfolio in the Tunnelling Industry and is an ASSDA Specialist Fabricator.



Lindapter Weld-Free Steel Connectors

Leviat distributes Lindapter products in Australia. The range includes Hollo-Bolt™, girder clamps, rail clips and floor fixings.



Products for Brick, Block & Stone



Ancon MDC Support System fixed to 30/20 cast-in channel



Ancon CFA Support System fixed to post-installed anchor

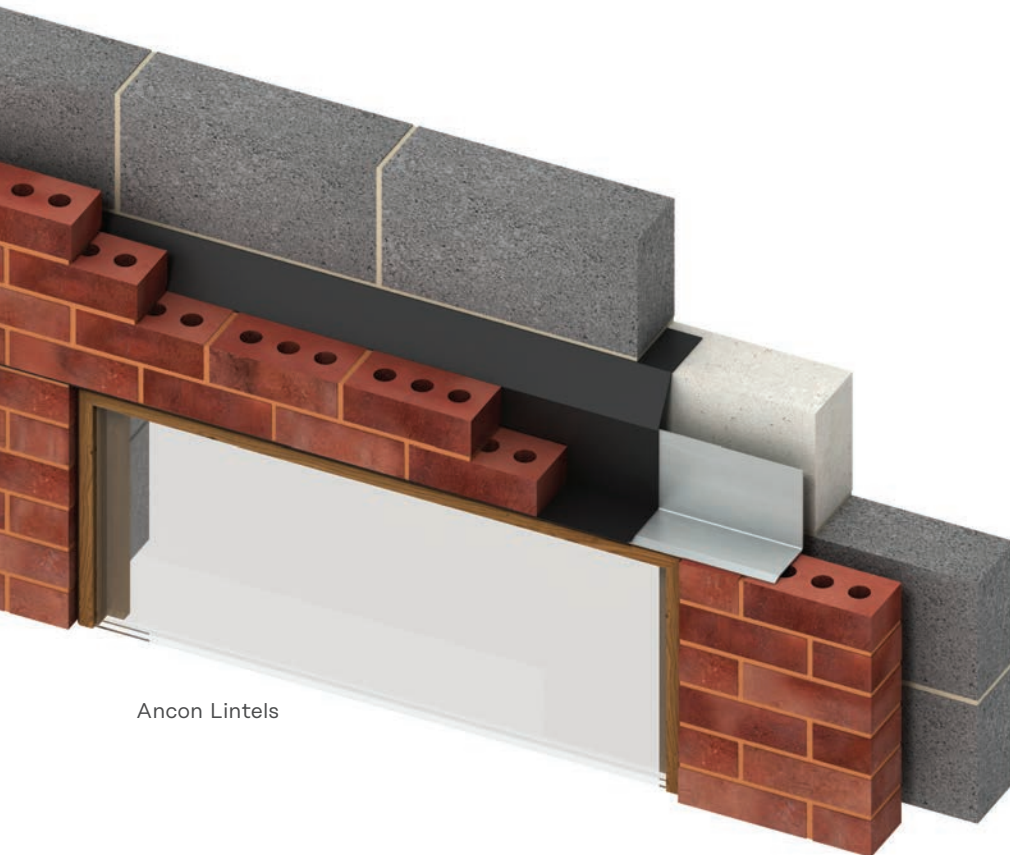

Ancon Lintels

Horizontal Support

Ancon Masonry Support Systems

Ancon masonry support systems facilitate horizontal movement joints and also enable architectural features to be created including large openings, concealed soffits and stepped façades. Our engineered solutions ensure support angles are cost effective and negate the need for cutting and waste on site.

Ancon masonry support systems and lintels are manufactured from stainless steel and are suitable for all Australian durability classes without any further corrosion protection.

Ancon Lintels

The Ancon lintel range suits the majority of wall constructions and load conditions. Special lintels can be manufactured to suit architectural features and non-standard applications.

Ancon Channel & Bolt Fixings

A wide range of channels and bolts are available to fix stainless steel masonry supports and restraints to any type of structural frame.

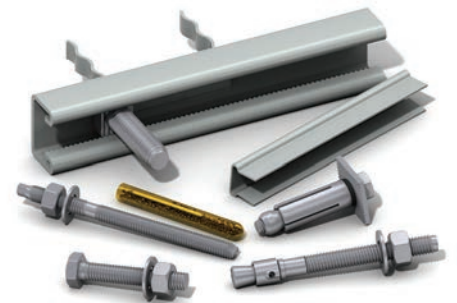

Channel & Bolt Fixings



Individual Ancon MDC/SC Stonework Support Brackets

Masonry Restraints

Ancon Wall Ties & Restraint Fixings

Ancon manufactures wall ties in a variety of lengths and types for restraining brick, block and stone. These restraints can be designed to fix to concrete, structural steel and timber as well as any type of masonry.

In addition to cavity wall ties, products include head restraints for use at the top of internal walls, wall starter systems comprising a channel and ties, and debonded ties for vertical movement joints.



Ancon AMD Cavity Ties and PPB Movement Ties

Strengthening Masonry Panels

Ancon Windposts & Bed Joint Reinforcement

Ancon Windposts span vertically between floors. Profiles include channel and angle sections. They are designed to suit specific applications and are supplied complete with all end connections and wall ties.

Ancon AMR steel ladder-type reinforcement locates in the bed joint to strengthen wall panels against lateral loads.

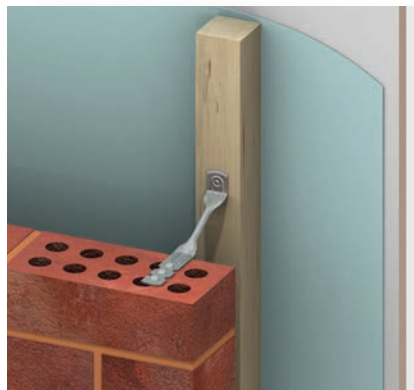

Ancon AMD Veneer Tie



Ancon WP2 Windpost



Ancon AMR Masonry Reinforcement



Products for Masonry Repair

Helical Wall Ties, Fixings & Masonry Repair Systems

Strengthening and Stabilising Masonry

HeliBar is a helical stainless steel reinforcing bar, with substantial tensile properties, used for strengthening and stabilising masonry in both new build and remedial situations. Helibars can be used to form masonry beams that secure large areas of masonry, distributing the structural loads and overcoming various problems caused by foundation movement.



Crack Stitching Systems

The Helifix Crack Stitching system repairs and stabilises cracked masonry using stainless steel HeliBars bonded into cut slots with HeliBond grout for a quick, simple, effective and permanent solution.

Remedial Wall Ties

Remedial wall ties are installed to tie masonry leaves together or veneers to internal structural frames. The Helifix range offers a solution for all situations and materials including ResiTies and BowTies.

Mechanical Pinning Systems

Helifix DryFix is a versatile and rapidly installed mechanical pinning and remedial tying system that requires no resin, grout or mechanical expansion. DryFix ties are installed directly into the brick leaves.



Piled Foundation Systems

Helifix Dixie Micro-Pile circular hollow section piles provide rapid and reliable structural support to a building's foundations following subsidence and can also act as a piled foundation system for either permanent or temporary new-build construction.

Worldwide contacts for Leviat:

Australia

Leviat
98 Kurrajong Avenue,
Mount Druitt Sydney, NSW 2770
Tel: +61 - 2 8808 3100
Email: info.au@leviat.com

Austria

Leviat
Leonard-Bernstein-Str. 10
Saturn Tower, 1220 Wien
Tel: +43 - 1 - 259 6770
Email: info.at@leviat.com

Belgium

Leviat
Industrielaan 2
1740 Ternat
Tel: +32 - 2 - 582 29 45
Email: info.be@leviat.com

China

Leviat
Room 601 Tower D, Vantone Centre
No. A6 Chao Yang Men Wai Street
Chaoyang District
Beijing · P.R. China 100020
Tel: +86 - 10 5907 3200
Email: info.cn@leviat.com

Czech Republic

Leviat
Business Center Šafránková
Šafránková 1238/1
155 00 Praha 5
Tel: +420 - 311 - 690 060
Email: info.cz@leviat.com

Finland

Leviat
Vädursgatan 5
412 50 Göteborg / Sweden
Tel: +358 (0)10 6338781
Email: info.fi@leviat.com

France

Leviat
6, Rue de Cabanis
FR 31240 L'Union
Toulouse
Tel: +33 - 5 - 34 25 54 82
Email: info.fr@leviat.com

Germany

Leviat
Liebigstrasse 14
40764 Langenfeld
Tel: +49 - 2173 - 970 - 0
Email: info.de@leviat.com

India

Leviat
309, 3rd Floor, Orion Business Park
Ghodbunder Road, Kapurbawdi,
Thane West, Thane,
Maharashtra 400607
Tel: +91 - 22 2589 2032
Email: info.in@leviat.com

Italy

Leviat
Via F.lli Bronzetti 28
24124 Bergamo
Tel: +39 - 035 - 0760711
Email: info.it@leviat.com

Malaysia

Leviat
28 Jalan Anggerik Mokara 31/59
Kota Kemuning, 40460 Shah Alam
Selangor
Tel: +603 - 5122 4182
Email: info.my@leviat.com

Netherlands

Leviat
Oostermaat 3
7623 CS Borne
Tel: +31 - 74 - 267 14 49
Email: info.nl@leviat.com

New Zealand

Leviat
2/19 Nuttall Drive, Hillsborough,
Christchurch 8022
Tel: +64 - 3 376 5205
Email: info.nz@leviat.com

Norway

Leviat
Vestre Svanholmen 5
4313 Sandnes
Tel: +47 - 51 82 34 00
Email: info.no@leviat.com

Philippines

Leviat
2933 Regus, Joy Nostalg,
ADB Avenue
Ortigas Center
Pasig City
Tel: +63 - 2 7957 6381
Email: info.ph@leviat.com

Poland

Leviat
Ul. Obornicka 287
60-691 Poznan
Tel: +48 - 61 - 622 14 14
Email: info.pl@leviat.com

Singapore

Leviat
14 Benoi Crescent
Singapore 629977
Tel: +65 - 6266 6802
Email: info.sg@leviat.com

Spain

Leviat
Poligono Industrial Santa Ana
c/ Ignacio Zuloaga, 20
28522 Rivas-Vaciamadrid
Tel: +34 - 91 632 18 40
Email: info.es@leviat.com

Sweden

Leviat
Vädursgatan 5
412 50 Göteborg
Tel: +46 - 31 - 98 58 00
Email: info.se@leviat.com

Switzerland

Leviat
Grenzstrasse 24
3250 Lyss
Tel: +41 - 31 750 3030
Email: info.ch@leviat.com

United Kingdom

Leviat
President Way, President Park,
Sheffield, S4 7UR
Tel: +44 - 114 275 5224
Email: info.uk@leviat.com

United States of America

Leviat
6467 S Falkenburg Rd.
Riverview, FL 33578
Tel: (800) 423-9140
Email: info.us@leviat.us

For countries not listed

Email: info@leviat.com

Leviat.com

Notes regarding this catalogue

© Protected by copyright. The construction applications and details provided in this publication are indicative only. In every case, project working details should be entrusted to appropriately qualified and experienced persons. Whilst every care has been exercised in the preparation of this publication to ensure that any advice, recommendations or information is accurate, no liability or responsibility of any kind is accepted by Leviat for inaccuracies or printing errors. Technical and design changes are reserved. With a policy of continuous product development, Leviat reserves the right to modify product design and specification at any time.

Leviat[®]
A CRH COMPANY

Imagine. Model. Make.

[Leviat.com](https://www.leviat.com)